

A	B	C	D	A	B	C	D	A	B	C	D			
1	S322-0027	895	240	4/5	7	S322-1142	248	516	1/5	13	S322-9933	865	505	1/5
2	S322-0028	895	240	4/5	8	S322-1143	1716	518	1/5	14	S322-9935	2017	455	1/5
3	S322-0029	1708	446	5/5	9	S322-2214	1883	551	2/5	15	ZB-5512	835	200	3/5
4	S322-0030	1708	446	5/5	10	S322-3326	1799	537	2/5	16	BB-505	500	200	3/5
5	S322-1140	2060	540	1/5	11	S322-3327	1799	537	2/5	17	BB-506	500	200	3/5
6	S322-1141	2060	540	1/5	12	S322-3328	891.5	517	1/5	18	dr-887	887	22	2/5
										19	Lh-1977	1977	14	1/5

A	B	C	D	
20	S322-329	890.5	513	1/1

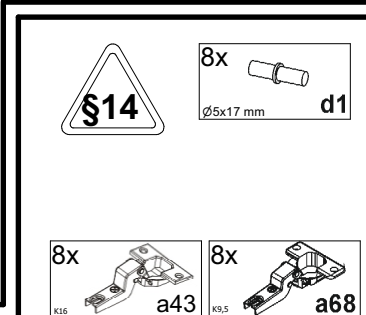
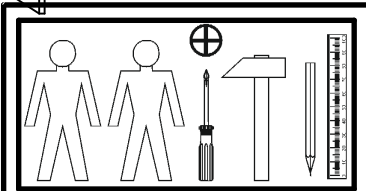
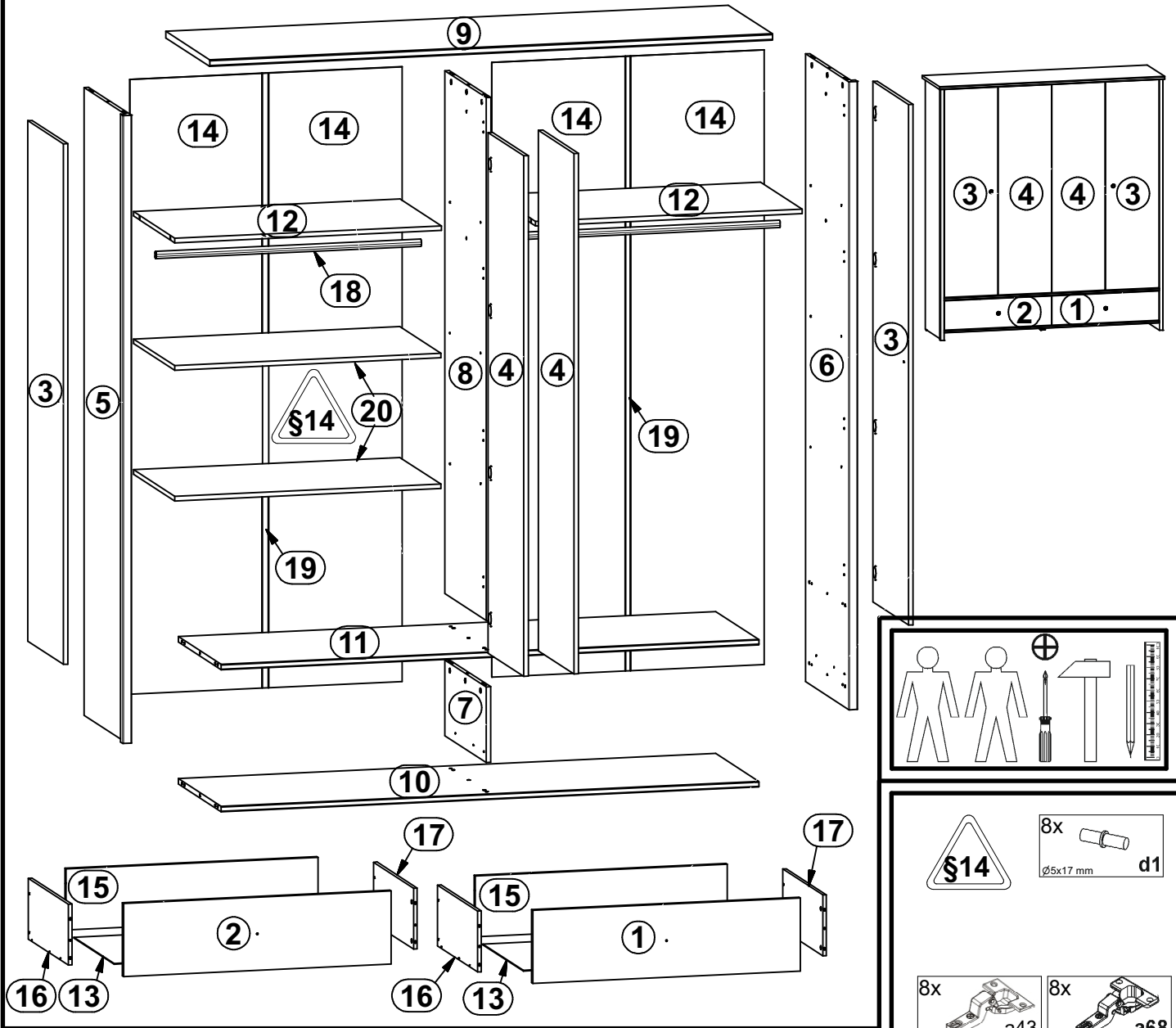

8x b19	8x b33	4x c415	6x e1	1x e2	9x e3	12x e19	24x f1	2x p25
8x f25	4x j1	4x k1	1x k38\3	1x k38\8	160x l1	4x n1	4x o21	4x p1
2x p35	16x p38	32x p51	3x p54	32x r1	8x r37	8x r36	32x r42	9x s2
2x t34	2x w26\CL	2x w26\CR	2x w26\DL	2x w26\DR	1x z1			

1

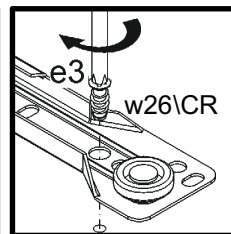
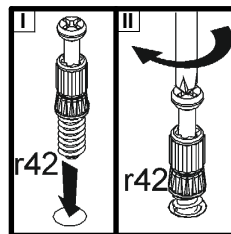
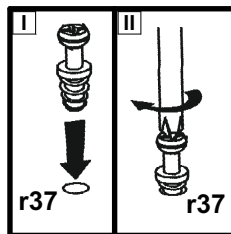
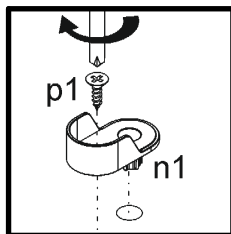
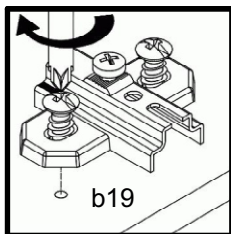
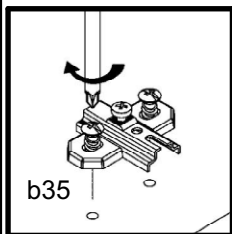
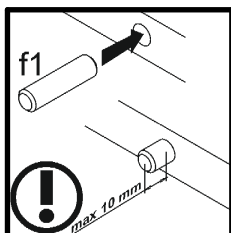
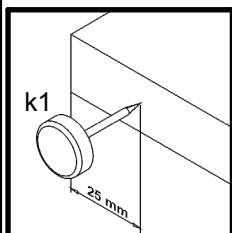
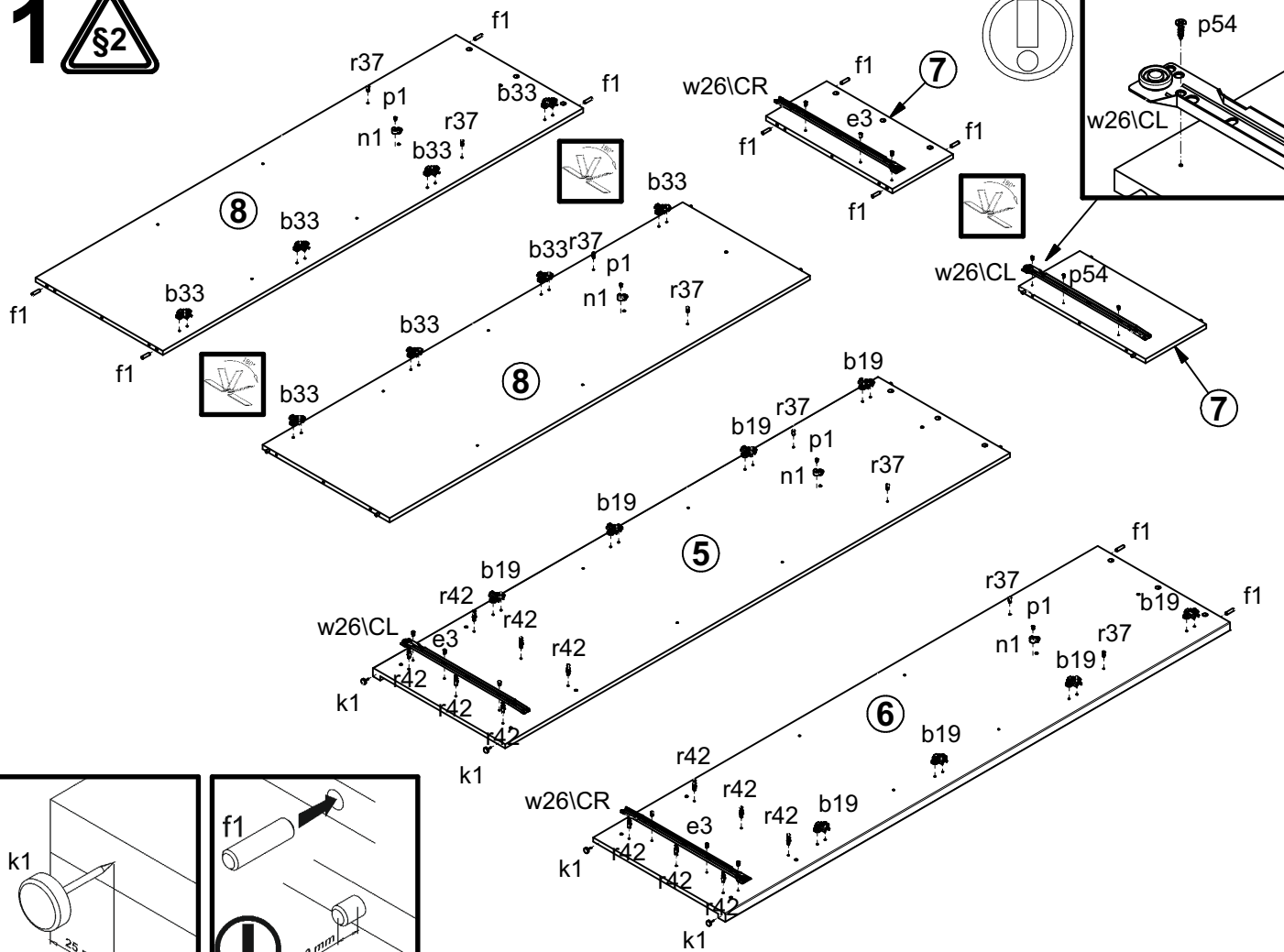

2

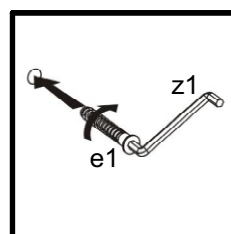
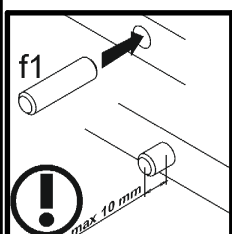
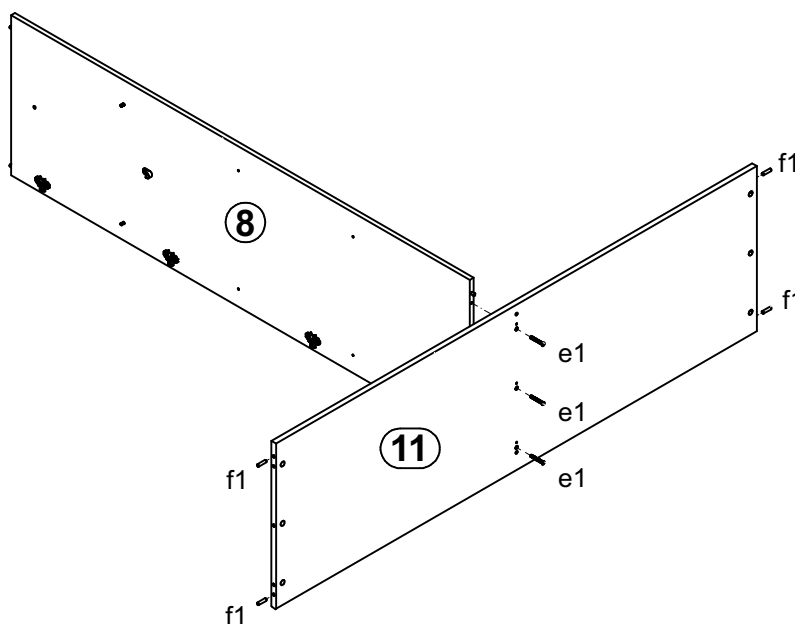

3

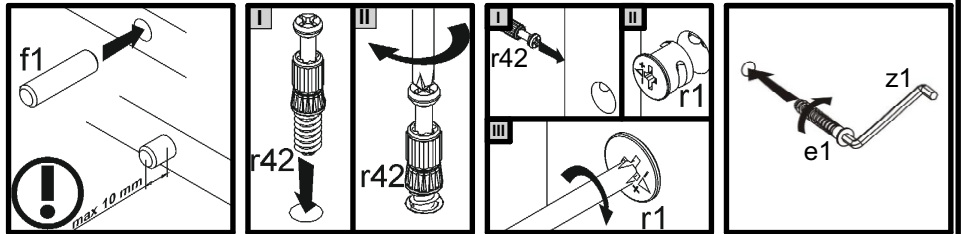
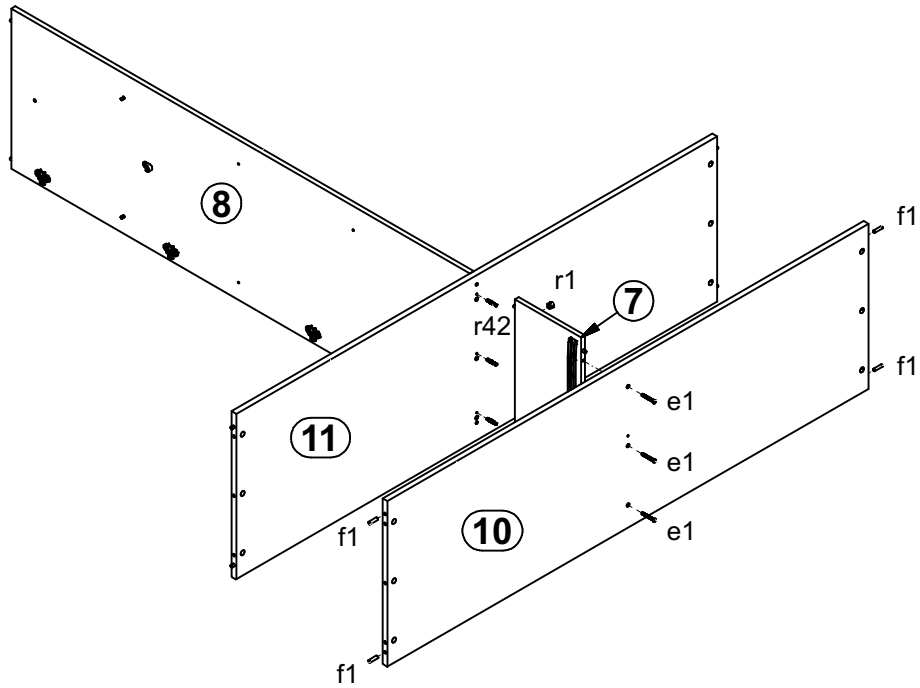

4

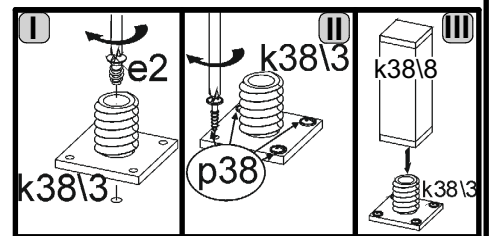
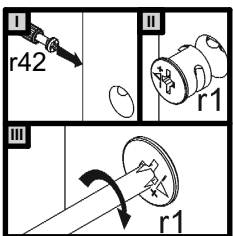
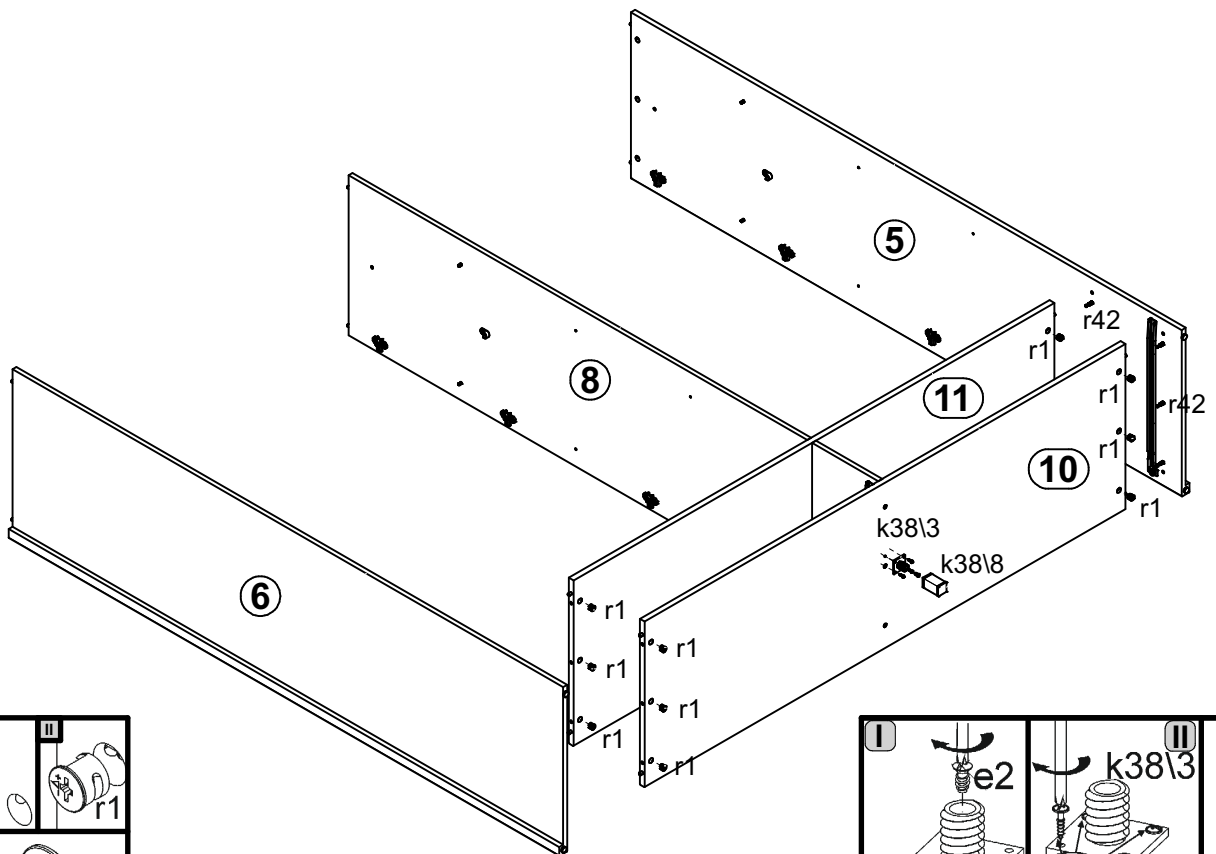

5

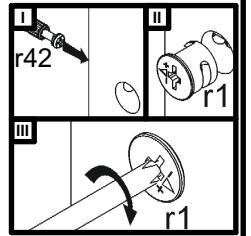
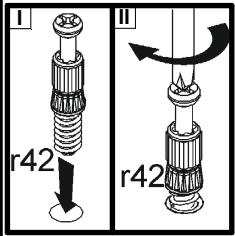
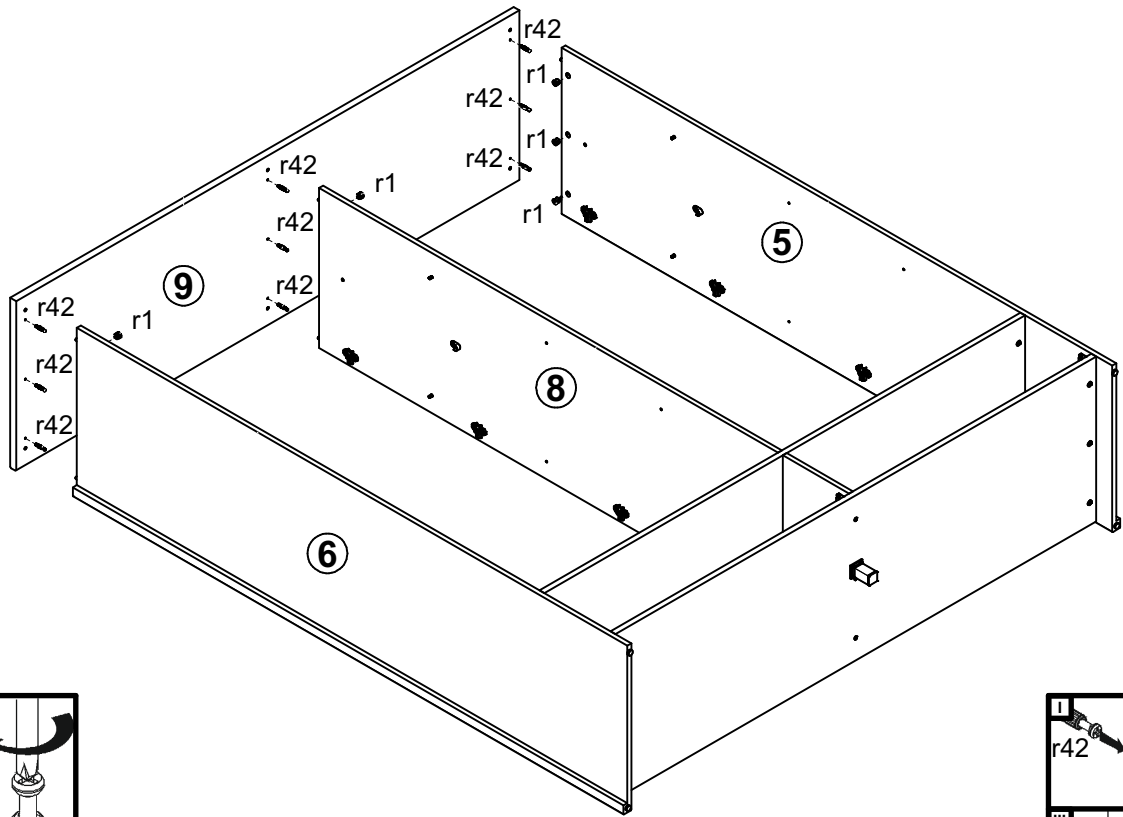

6

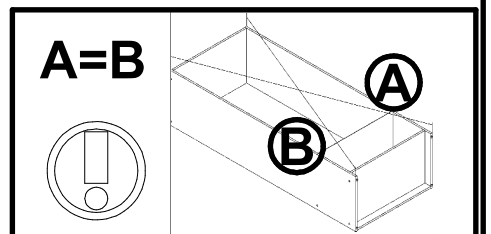
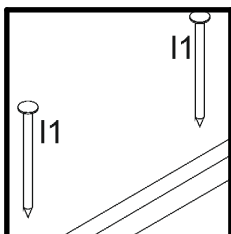
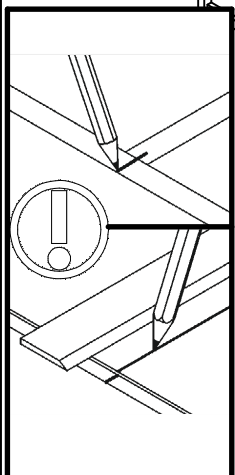
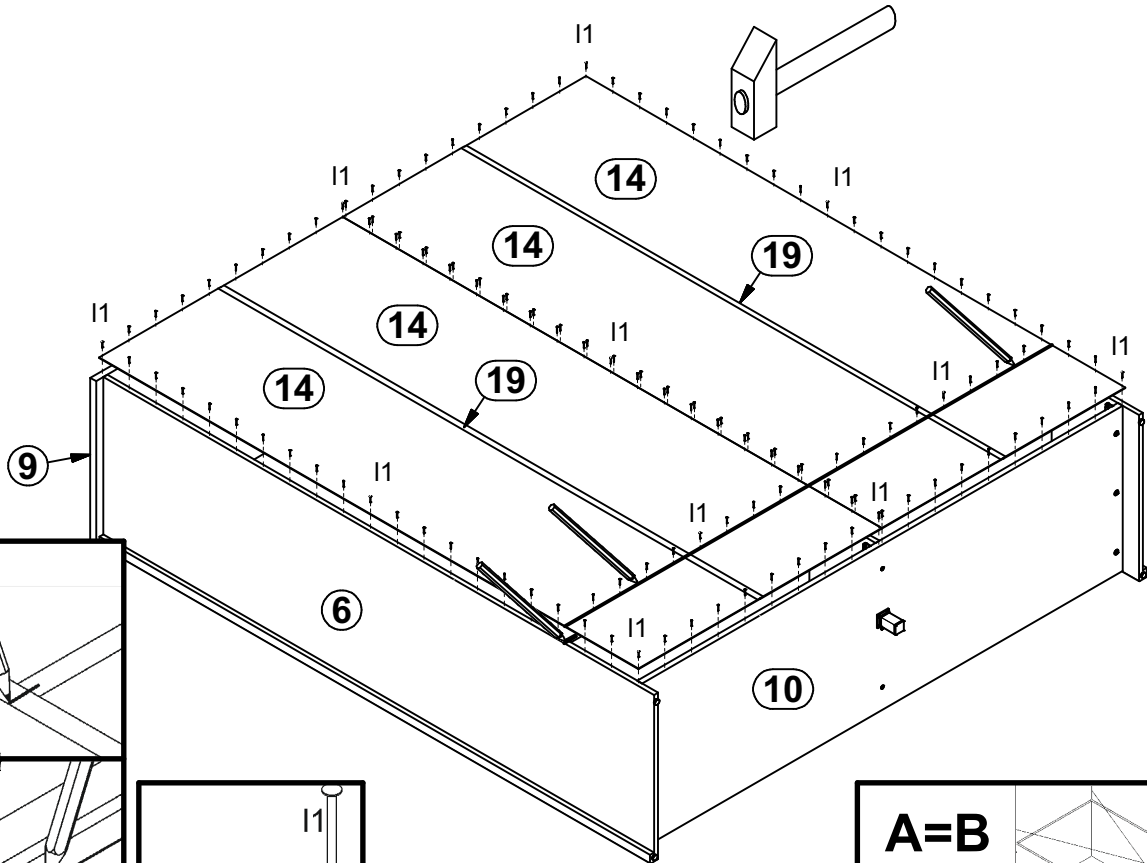

7

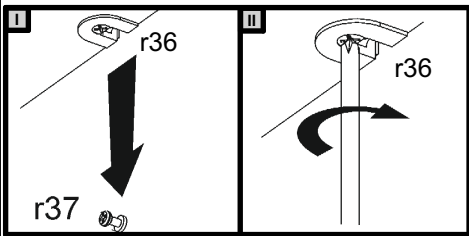
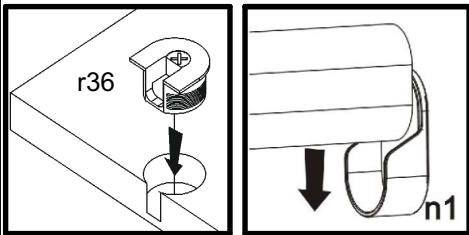
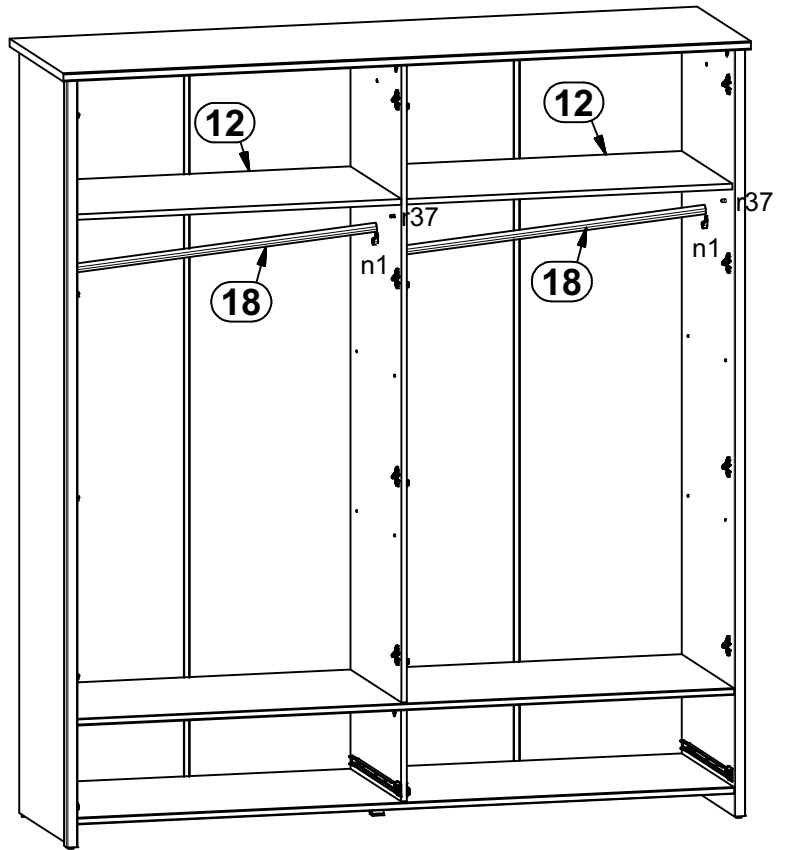
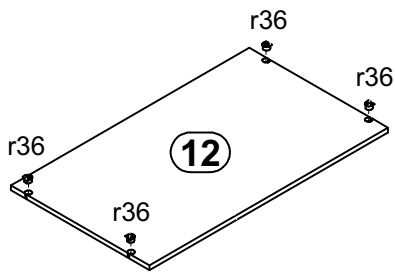

8

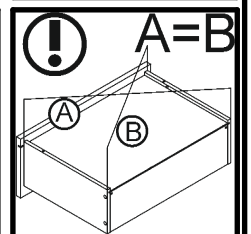
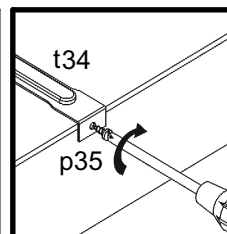
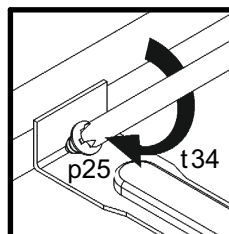
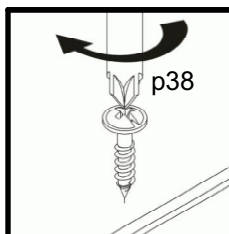
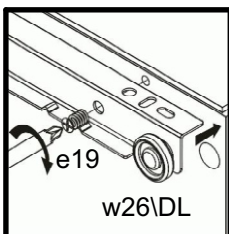
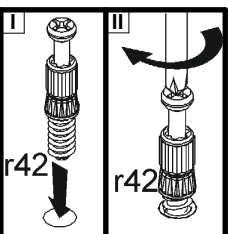
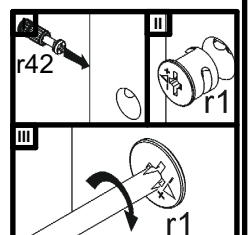
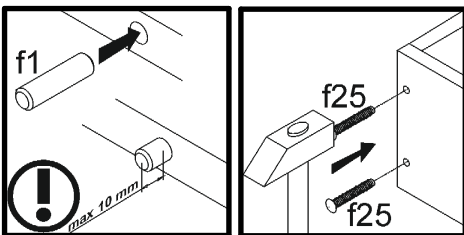
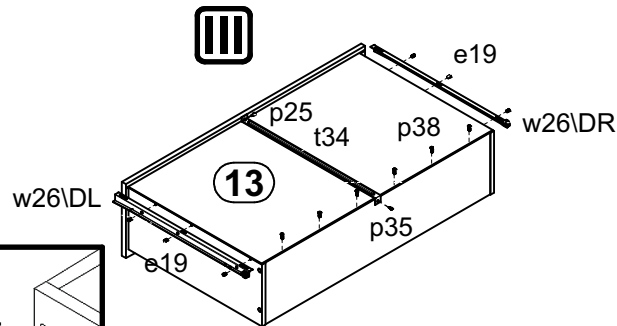
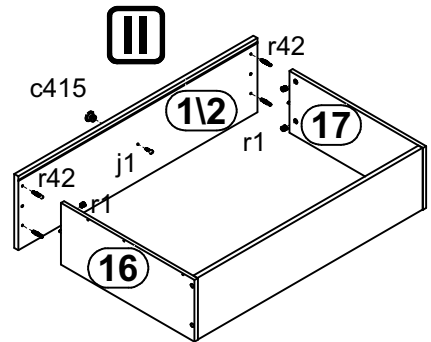
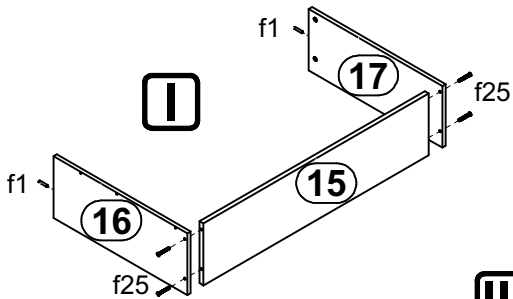

9

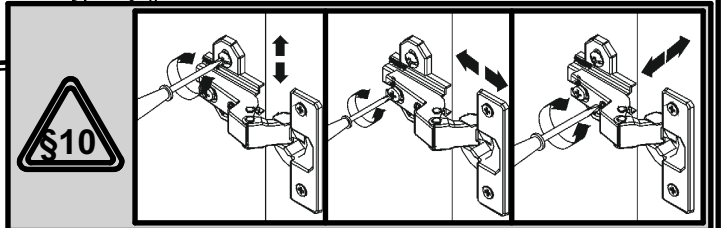
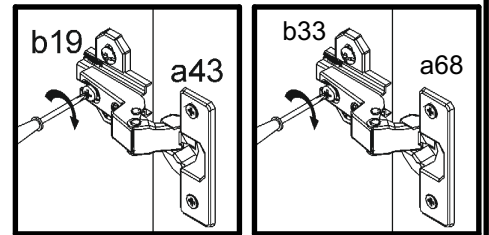
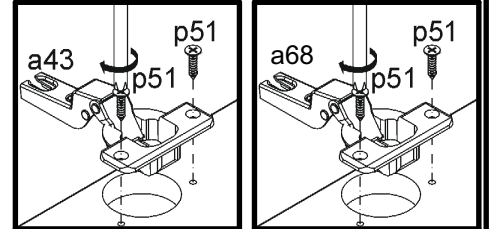
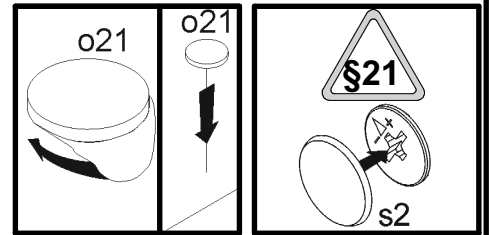
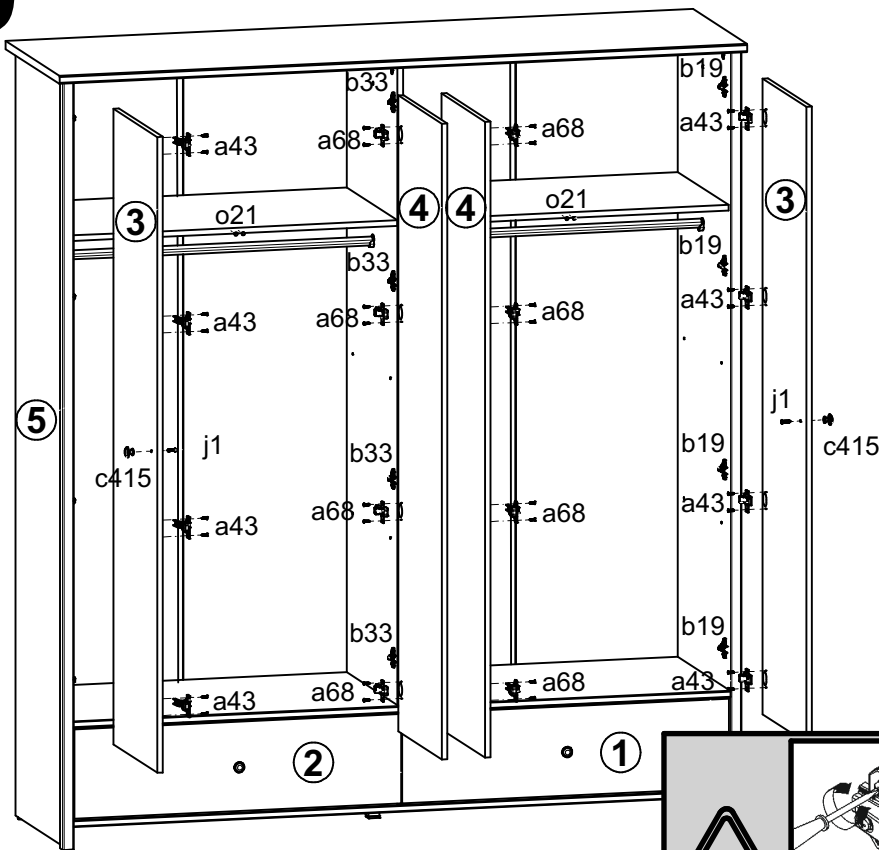

10

§14

